

Data Sheet

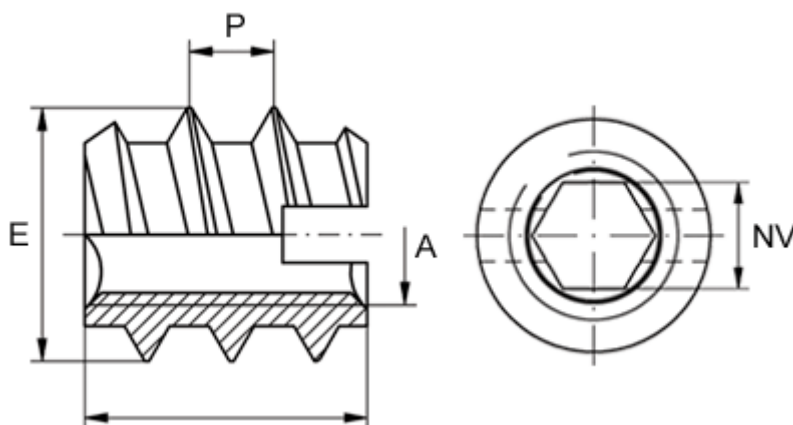

Article number: 12309200050800
Description: KLEE-coil 309 200 050.800
M5 Brass

Measures



Female thread A	= M5
Internal hexagon NV +0.1	= 4.0
Length B	= 12
Male thread E	= 9.0
Min hole depth	= 15
Recommended bore diameter (plastic/hard wood)	= 6.7 to 6.9
Recommended bore diameter, soft wood (largest)	= 7.0
Thread pitch P	= 3.0